

71-0028-99 (-"X")

8-FAUCET STAINLESS ONE DRAINER  
CENTER HOLE & "X" = LEFT OR RIGHT

DWG NO:  
1150021

APPROVED/DATE:

REV:  
A

JOB:

ITEM #

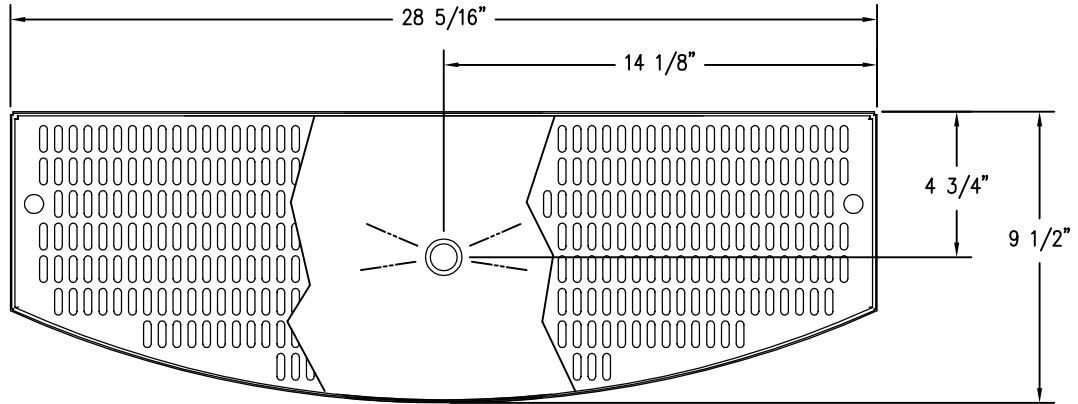

DRAINER: 71-0028-99

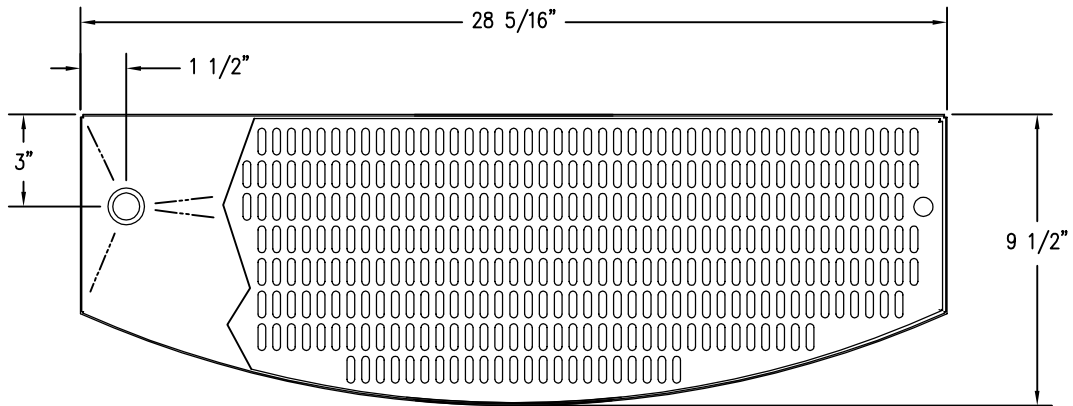

DRAINER: 71-0028-99-L

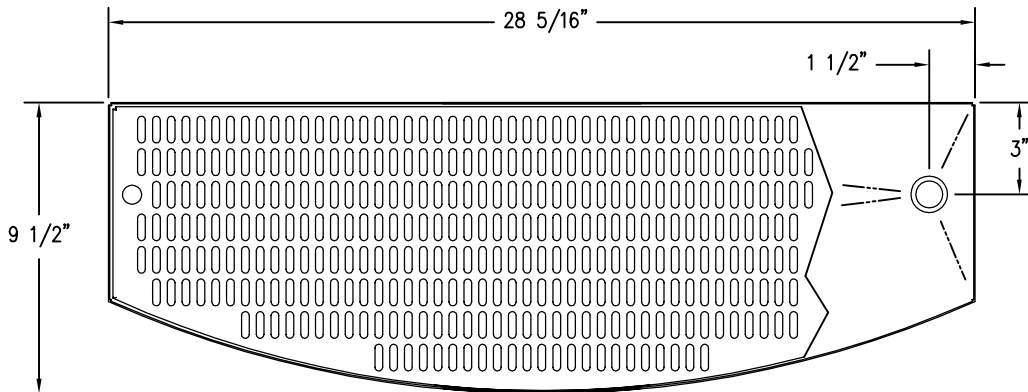

DRAINER: 71-0028-99-R

1150021A.DWG / 6-23-2008

# Wunder-Bar

Dispensing Systems

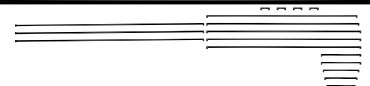

AUTOMATIC BAR CONTROLS, INC.  
790 EUBANKS DRIVE  
VACAVILLE, CA 95688

WWW.WUNDERBAR.COM

TOLL FREE : (800) 722-6738  
PHONE: (707) 448-5151  
FAX : (707) 448-1521