

MARK 4 12-BUTTON POST MIX MANIFOLD

JOB:

ITEM#:

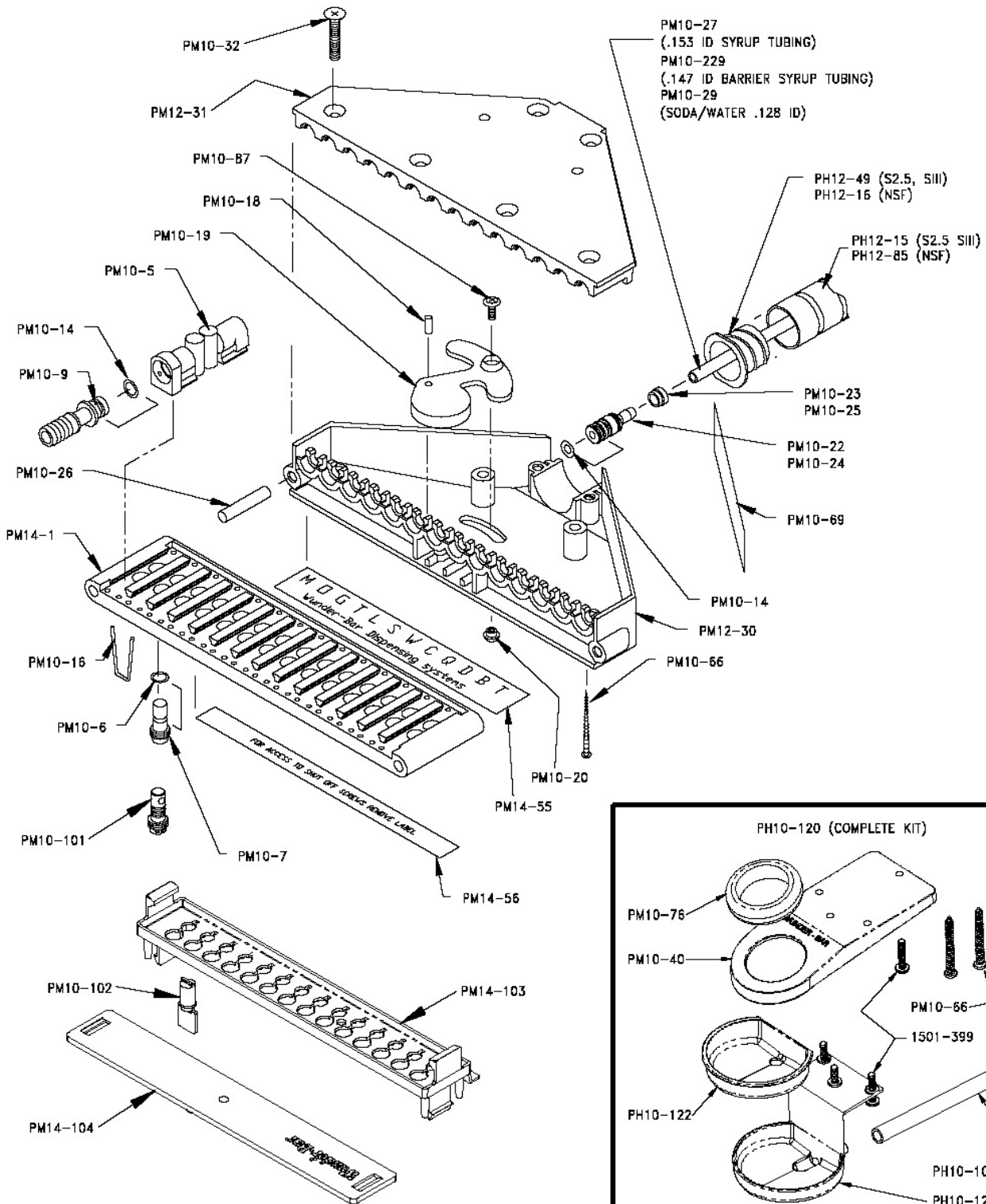

0550079.DWG / 05 APR 2010

Wunder-Bar Dispensing Systems

AUTOMATIC BAR CONTROLS, INC.
790 EUBANKS DRIVE
VACAVILLE, CA 95688

PHONE: (707) 448-5151
FAX : (707) 448-1521
www.wunderbar.com